



Ifremer

OFEG-TECH MEETING 2018

IFREMER NEW'S



National fleet



Ifremer

Fleet owned/operated by 4 national institutes

- ✓ Ifremer : 5 ships from 25 to 107m
- ✓ IPEV : 1 ship – 125m
- ✓ CNRS : 2 coastal ships – 25m
- ✓ IRD : 2 regional ships 25-35m

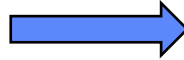

To improve

- ✓ Coordination of fleet planning
- ✓ Standardisation of scientific equipment
- ✓ Visibility for our ministries (fleet renewal plan)

Ifremer





New organisation



Ifremer

From January 2018 :

Ifremer will manage :

- ✓ The national fleet maintenance and upgrade
- ✓ The national fleet planning
- ✓ The fleet renewal plan

New Ifremer internal organisation :

- ✓ Merging of technical and program divisions = approx 70 people

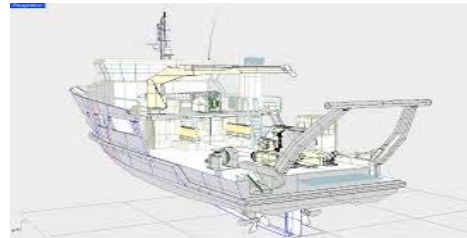



Ocean class vessels



Marion Dufresne - 120m



Pourquoi pas? (2005) - 107m



L'Atalante (1990) - 85m



Thalassa (1996) - 75m

Regional class vessel



L'Europe(1978) - 30 m



Thalia (1978) - 30 m



ALIS (1987) - 30 m



Thétys (1993) - 25m



Côte de la Manche (1997) - 25m



Antea (1995) - 36m



Mid life R/V Thalassa refit



Ifremer



RV Thalassa

- Built in 1996
- Length : 73,6m
- Width : 14,9m
- Disp. : 3022t



Modernization

- Project cost : 17 M€ - Brittany region, ANR and FEDER
- Shipyard : PIRIOU NAVAL SERVICE – Concarneau, France
- Dry dock : June 3th – Sept 18th 2017
- Trials : until Oct 2th 2017

Discussions
with shipyards
(Autumn 2016)

Choice of the
Shipyard
(December
2016)

Studies
(Jan-June
2017)

Works
(June-Sept
2017)

Sea Trials
(Sept 2017)



Objectives



Ifremer



The R/V Thalassa is an oceanographic ship mainly dedicated to the missions of public service in the field of **fish stock assessment** and physical oceanography.

The aim of this modernization is to enlarge the capacity of the vessel in the fields of **marine geosciences** and deep sea environment.

The objectives of the modernization are:

- to ensure the remedial and curative maintenance at mid-life of the vessel,
- to modify vessel accommodation,
- to replace all obsolete scientific equipment by up-to-date ones,
- to provide a reliable and efficient platform appropriate to the coming 20 years of marine science.

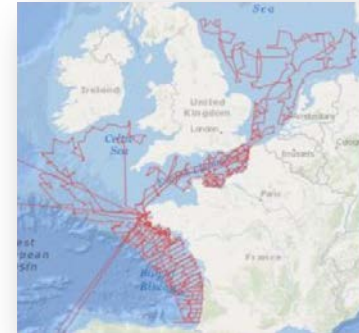



Scientific equipment up-grade



Fisheries:

- EK60 → EK80 (18, 38, 70, 120, 200, 333 kHz)
- 120kHz horizontal ranging
- new ME70 transducer (12 years old)
- Trawl monitoring system (Marport): no changes (positioning, openings...)
- ADCP: no change
- Hydrophone reference monitoring system (sabrina): upgraded

Addings:

- MBES: EM304 0,5°x1°+ EM2040 0,4°*0,7°
- Sub-bottom profiler
- USBL for ROV/AUV + Acoustic release system (IXBLUE)
- DVL (many systems currently in testing)

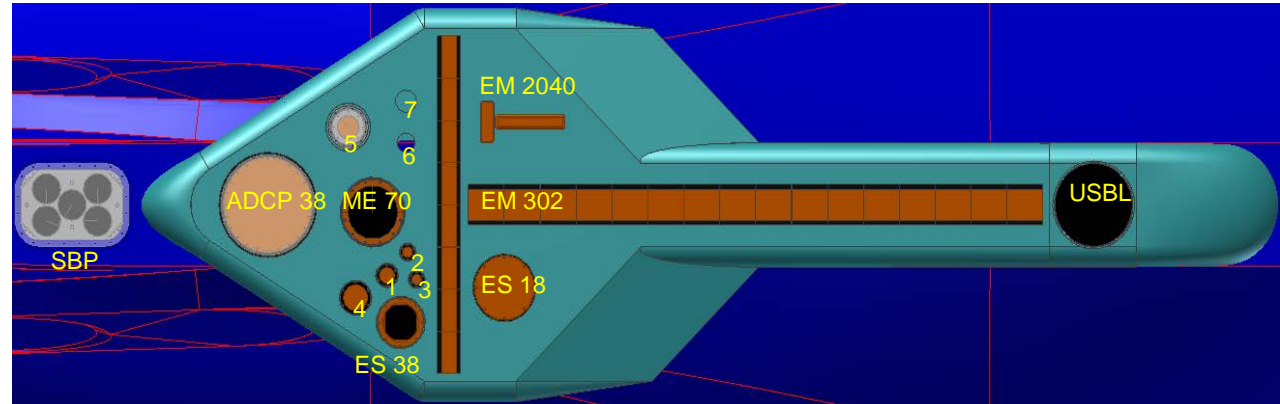

1 : ES 120

2 : ES 200

3 : ES 333

4 : ES 70

5 : ADCP 150

6 and 7 : ship sounders



The new fairing



Ifremer



Démontage équipements



Montage frames



Montage gondole



Montage bases



No gondola => same draft kept

A fairing under the keel



Ferrybox



Ifremer



Underway Measurement system (FERRYBOX) :

- conductivity (SBE21 + SBE45, temperature SBE38/SBE3S at water intake,
- dissolved oxygen,
- fluorimeter, turbidity,
- pCO₂,...

Provided by 4H JENA (Germany)





Informatics



Ifremer



- IT renewal : new storage capacity 20 TB => 100TB, network : 1Gbps ethernet for users, 10 to 40 Gbps, WIFI everywhere, new wall screen AVOCENT/EMERSON)

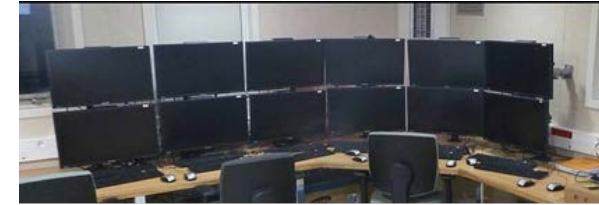

- Data acquisition, visualisation and transfert to shore – TECHSAS New Generation in development – Installed in double for endurance testing

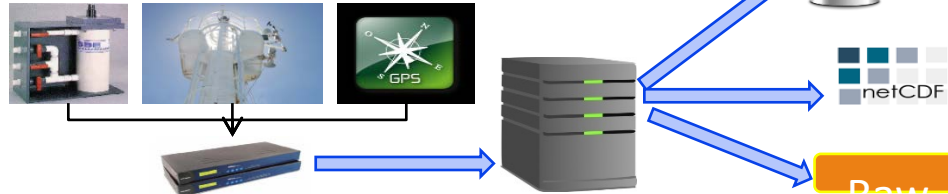
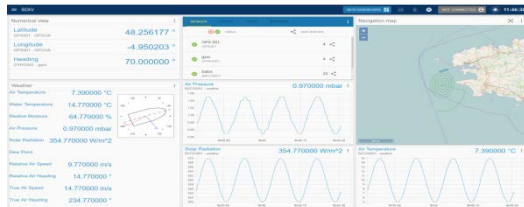



Two new cranes



New oceanographic HEILA knuckle crane
180t.m – 2 winches (4t & 13t) – 20m at full extension



SWL offshore conditions

- Dynamic 5t@8,5m
- Static 10t@4,5m
- Aux. winch 1t@8,5m

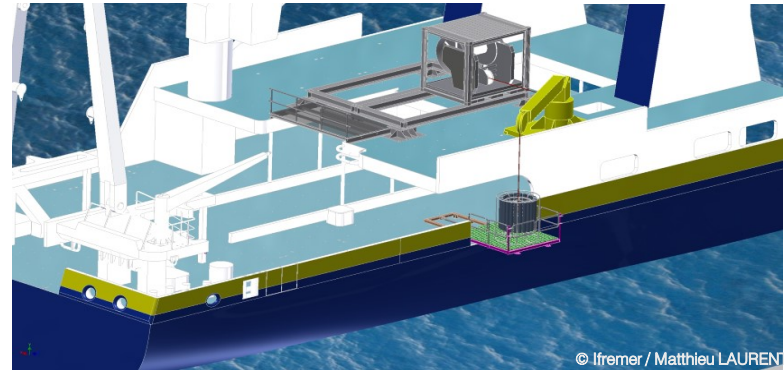
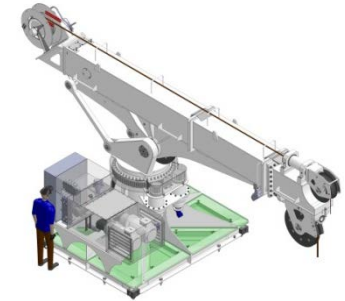

© Ifremer / Matthieu LAUREN

Custom design crane (KLEY FRANCE) for new CTD L/R and coring operations - Starboard shell plating opening and reinforcement



Large maintenance



- New gensets – Caterpillar 2*1500KVA & 2 * 1000 KVA
- New main propulsion converters (Thyristors to IGBT),
- New Power Management System (PMS)



Sortie DA

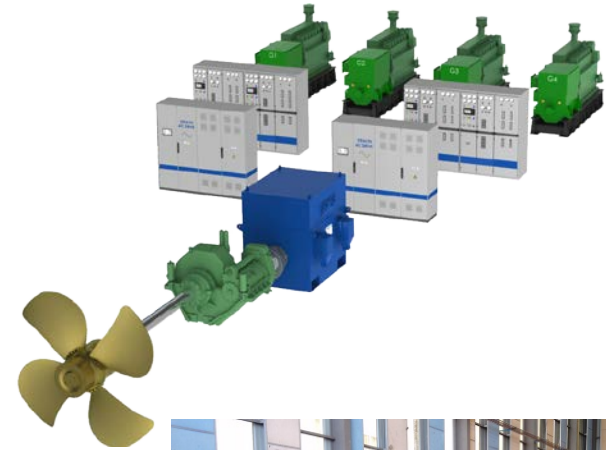

- Sheep steel central trawl track replace by a new one (10mm has reduced to 7mm)



Gensets

Noise



Comparison before and after modernisation – ICES standard

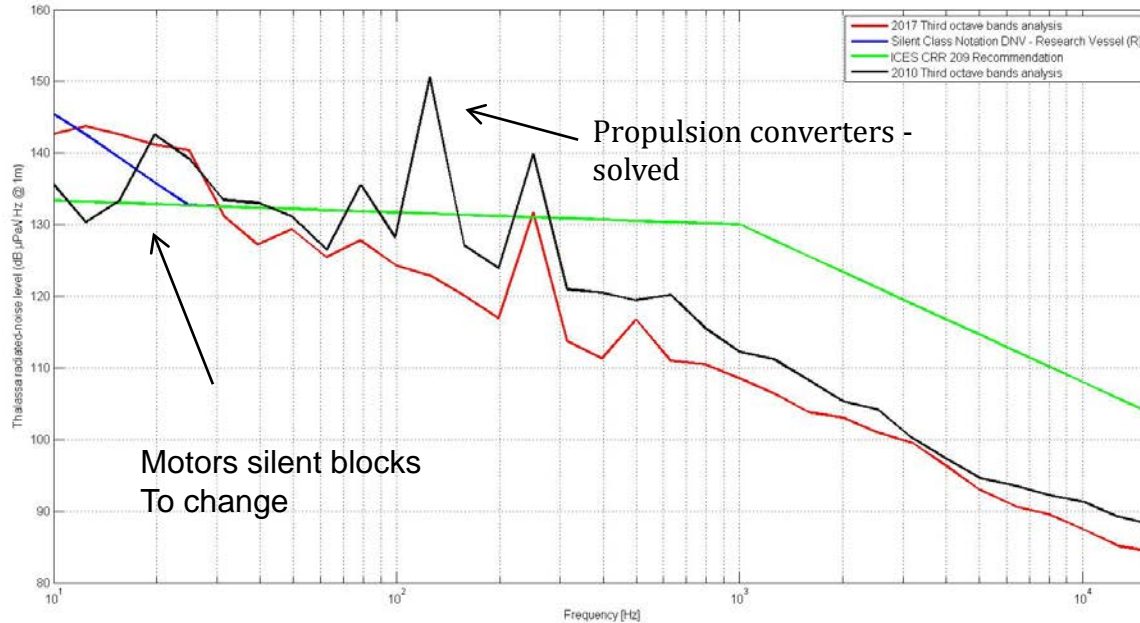



Seismic equipment renewal

SERCEL solid streamer technology



2014-2015

- 2D equip. with 4500m streamer
- HR 2D equip. with 600m streamer



2016

- 2D equip. 6000m streamer
- 2D equip. 1200m streamer
- 3D equip. 2 * 600m streamer

2017-2018

- Airs guns deployment
- Final trials



2D = 1 flûte + 1 source

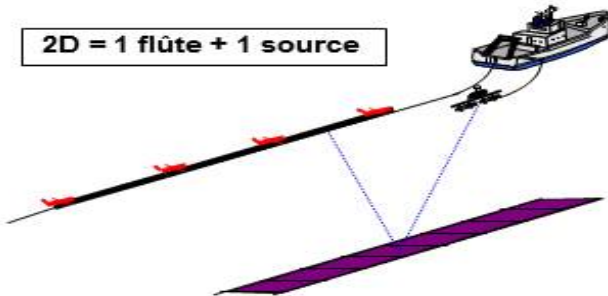

3D = 2 flûtes min + 2 sources

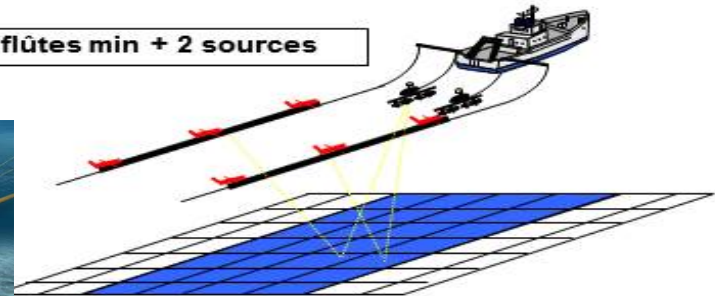
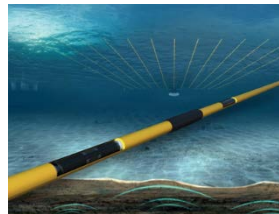



Seismic equipment renewal

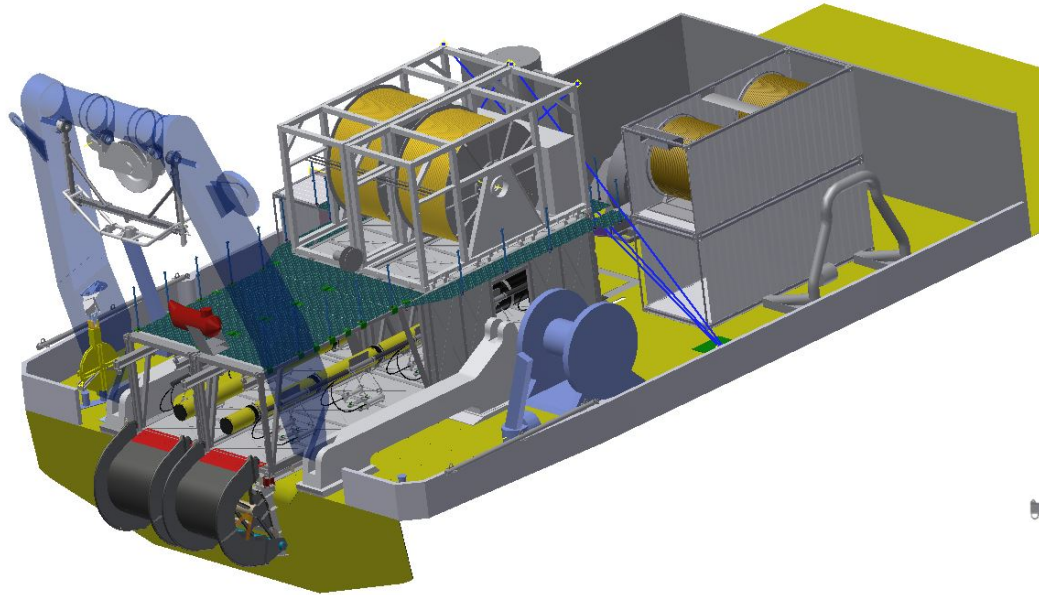

- KAPPA system (flexible floats) integrated in 2 * 40' containers
- 2 sub-arrays of 10 air guns max
- Guns depth adjustable 5, 10, 15m

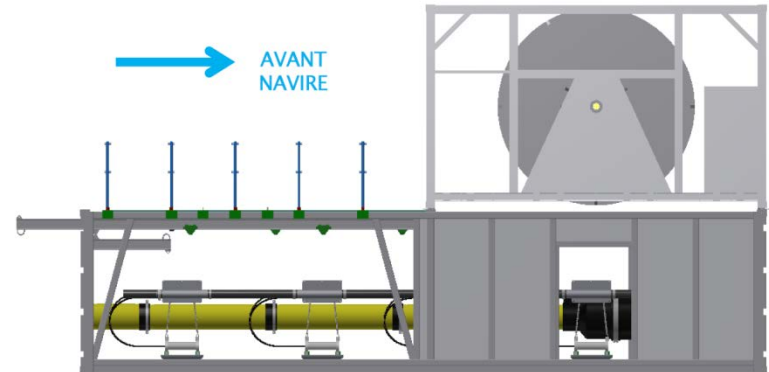

2D High penetration seismic arrangement on R/V *L'Atalante*



POLAR POD

The new project of Dr Jean-Louis Etienne



Ifremer

- Concept : « Vertical scientific ship based on US FLIP (Floating Instrument Platform)
- Expedition : 2 years circum-navigation around Southern Ocean
- **IFREMER is in charge of the construction of Polar Pod**

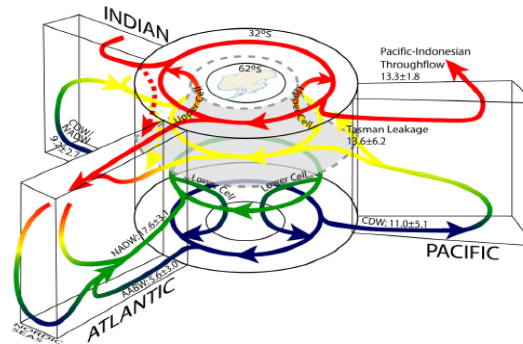
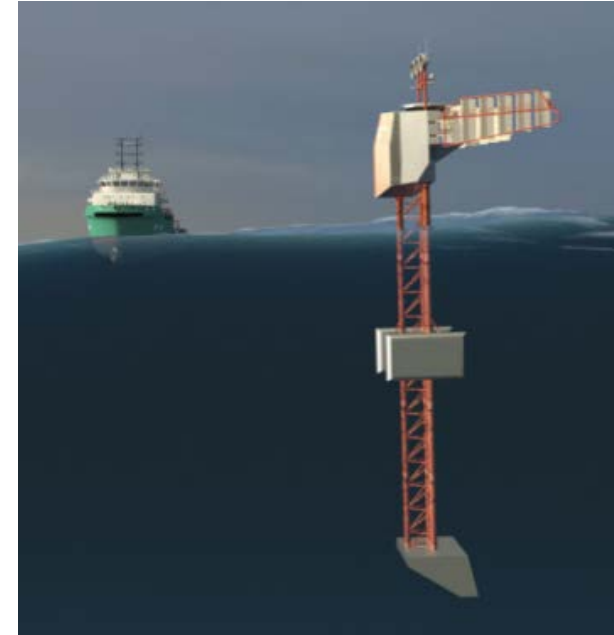



POLAR POD



- 22m length
- 80m draft
- 60m air draft
- 1000 t
- 8 persons
- <1,5 knts drift speed
- 4 wind turbines (2,5 kW)
- Emergency DA
- Emergency propeller (200 kW)

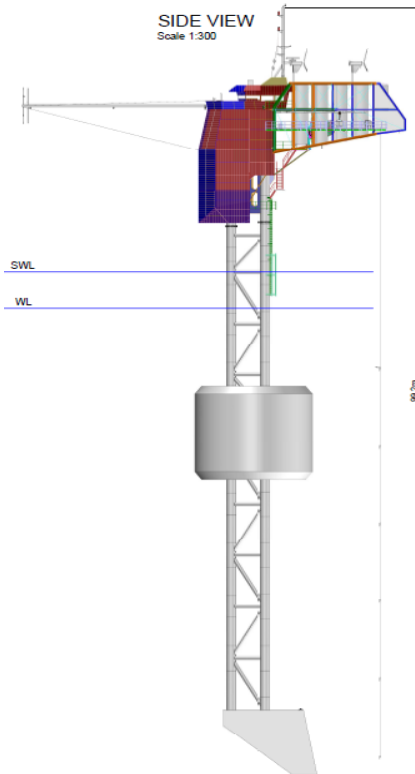

Environmental conditions

- Mean wind : <65 knts
- Gust : 136 knts
- Max waves $H_s=19$ m



Towed horizontally to the gyre



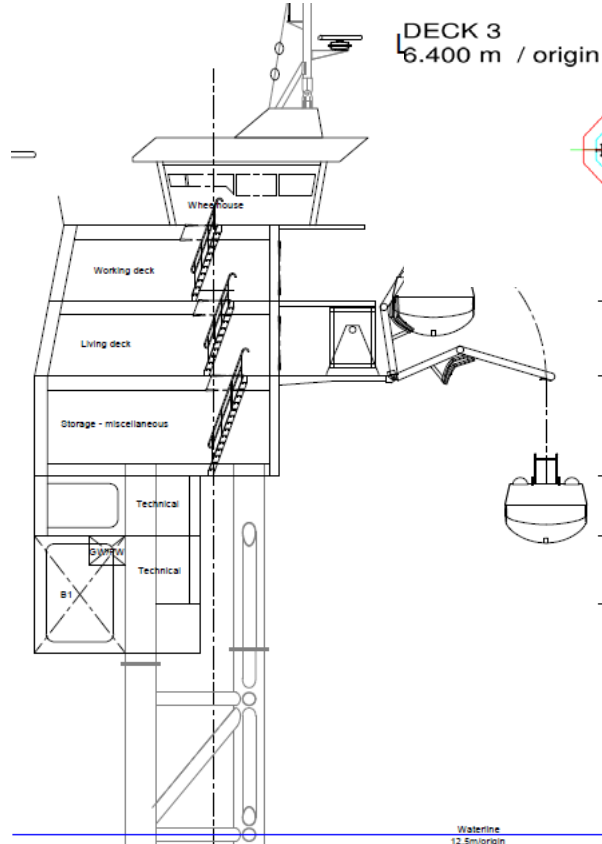

DECK 3
6.400 m / origin

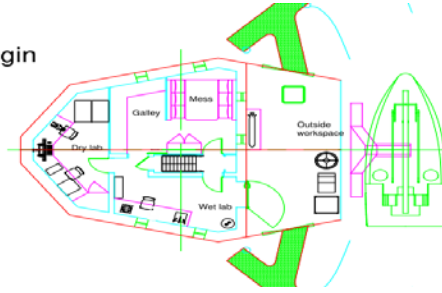

DECK 2
3.650 m / origin

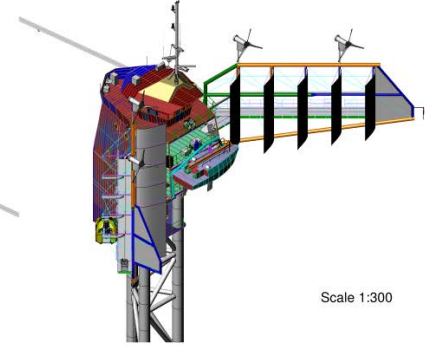
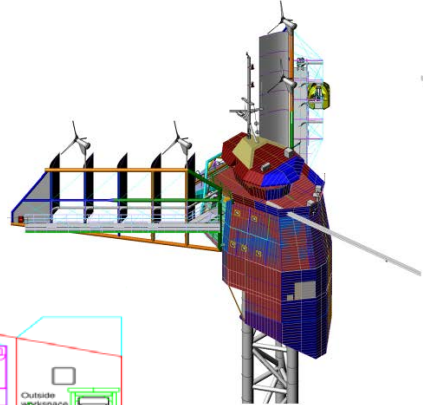
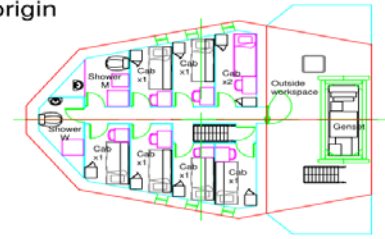

Scale 1:300

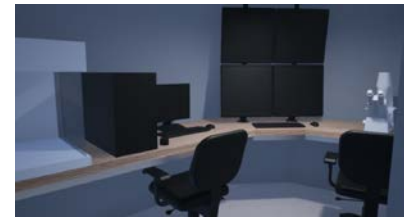



POLAR POD Scientific equipment



A large panoply of scientific equipment

- SBES
- Hydrophones
- ADCP
- CTD, CO2, N2, O2,..
- Lidars
- Samplers for contaminants
- Radiometers
- ROV
- ...

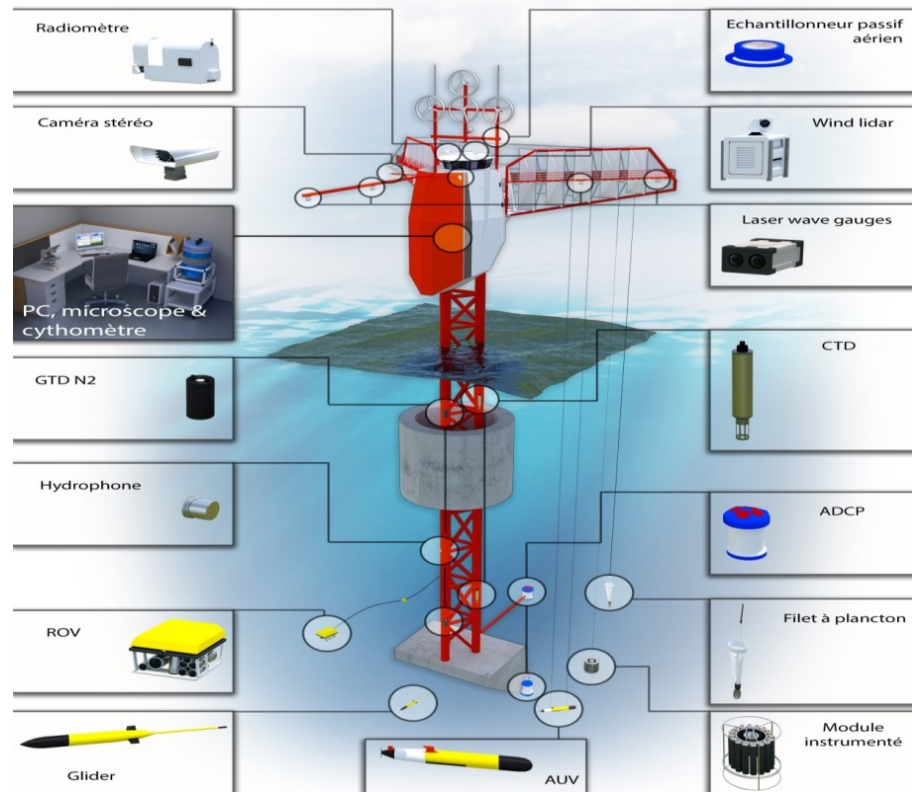
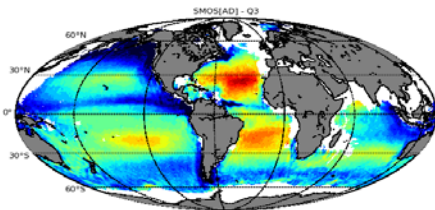
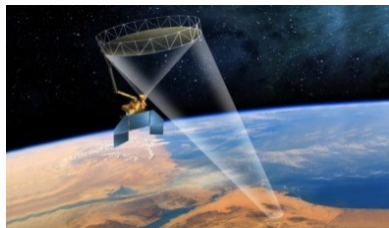



POLAR POD concept



Ifremer



Design

- ✓ Heave absorption 80%
- ✓ Surge acc. $< 0,03g$ /wave height
- ✓ Vertical acc. $< 0,007g$ /wave height

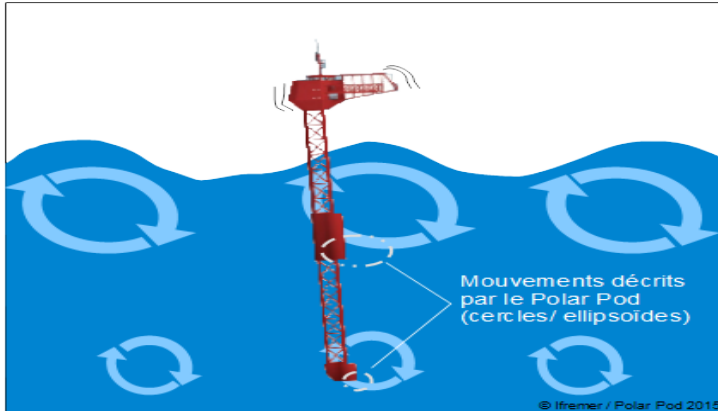



Transfert de personnel



Transfert

- Tous les 2-3 mois
- 8 personnes
- HS 4-5m
- Vent 5-6

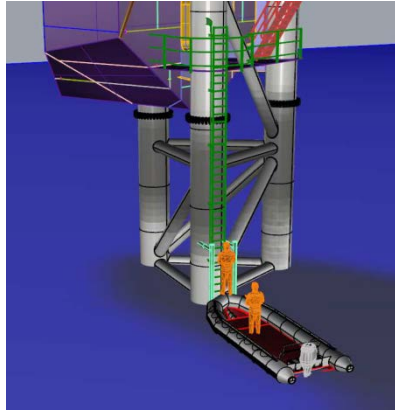

Boat landing

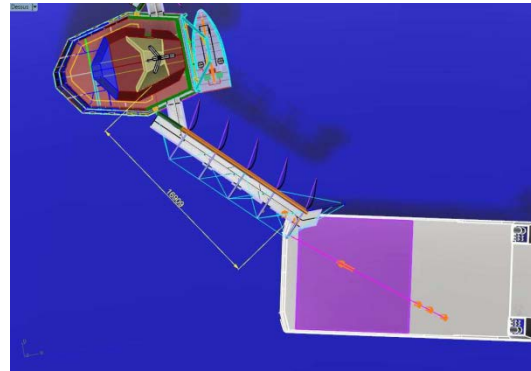
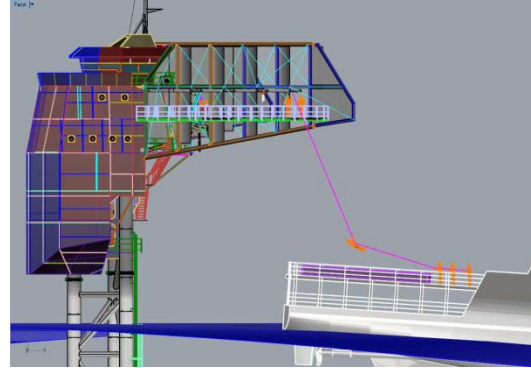

Tyrolienne

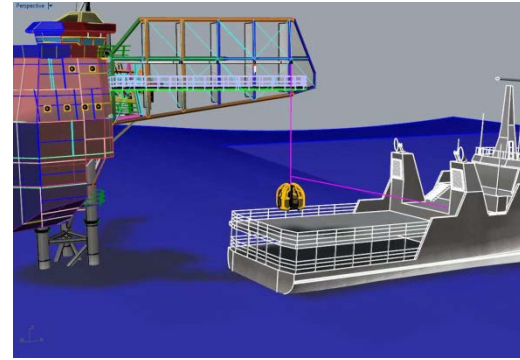
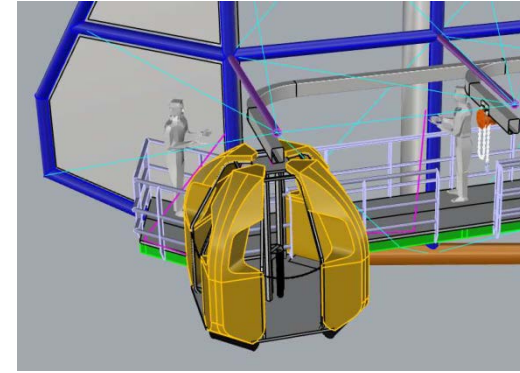

Capsule (Frog)

Statistiquement

2 fois par an, un état de mer supérieur à $H_s=4m$ dure plus de 17 jours d'affilée et 9 fois par an qu'il dure plus de 8 jours d'affilée.



Calendar



Ifremer

- ✓ Call for tender : October 2018
- ✓ Construction: : Until mid 2020
- ✓ Trials : Until end of 2020 (6 month)
- ✓ Arrivée sur zone : Juillet 2022
- ✓ Circumnavigation : Mid 2021 – Mid 2023



Ifremer

